

Article number: 03508140

Description: Fluro Rod end GE 140FW-2RS

Measures

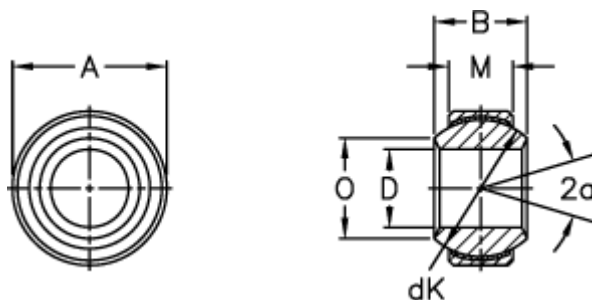

A = 230 0 -0,030

B = 130

D = 140 0 -0,025

dK = 200

Dynamic load C (kN) = 2560

M = 80

O = 151.9

Static load C0 (kN) = 5120

Tilt angle = 16

Weight = 18600